



US 20070166514A1

(19) **United States**

(12) **Patent Application Publication**  
**Friedman et al.**

(10) **Pub. No.: US 2007/0166514 A1**

(43) **Pub. Date: Jul. 19, 2007**

(54) **BLAST PROTECTION SYSTEM**

**Publication Classification**

(76) Inventors: **Keith Friedman**, Santa Barbara, CA  
(US); **D.Erich Weerth**, San Jose, CA  
(US)

(51) **Int. Cl.**  
**B32B 3/00** (2006.01)  
(52) **U.S. Cl.** ..... **428/156**

(57) **ABSTRACT**

This invention is a novel system for blast protection. It consists of lightweight, sectional or continuous barriers made of a blast resistant fiber reinforced polymer resin matrix composite, which may be fabricated on site. The barriers are lightweight and thin enough that they may be used in many spaces where barriers made from conventional construction materials are impossible, impractical, or undesirable. The novel barriers of this invention have the additional advantage of allowing for aesthetically appealing and architecturally harmonious designs. In order to minimize weight, the barriers may be designed such that the cross section varies with height, providing adequate resistance in areas of high blast loading, but allowing for thinner cross sections in regions of lower loading.

Correspondence Address:

**MARK RODGERS**  
**1590 SAN ROQUE ROAD**  
**SANTA BARBARA, CA 93105 (US)**

(21) Appl. No.: **11/589,619**

(22) Filed: **Oct. 30, 2006**

**Related U.S. Application Data**

(63) Continuation-in-part of application No. 10/924,431,  
filed on Aug. 23, 2004.

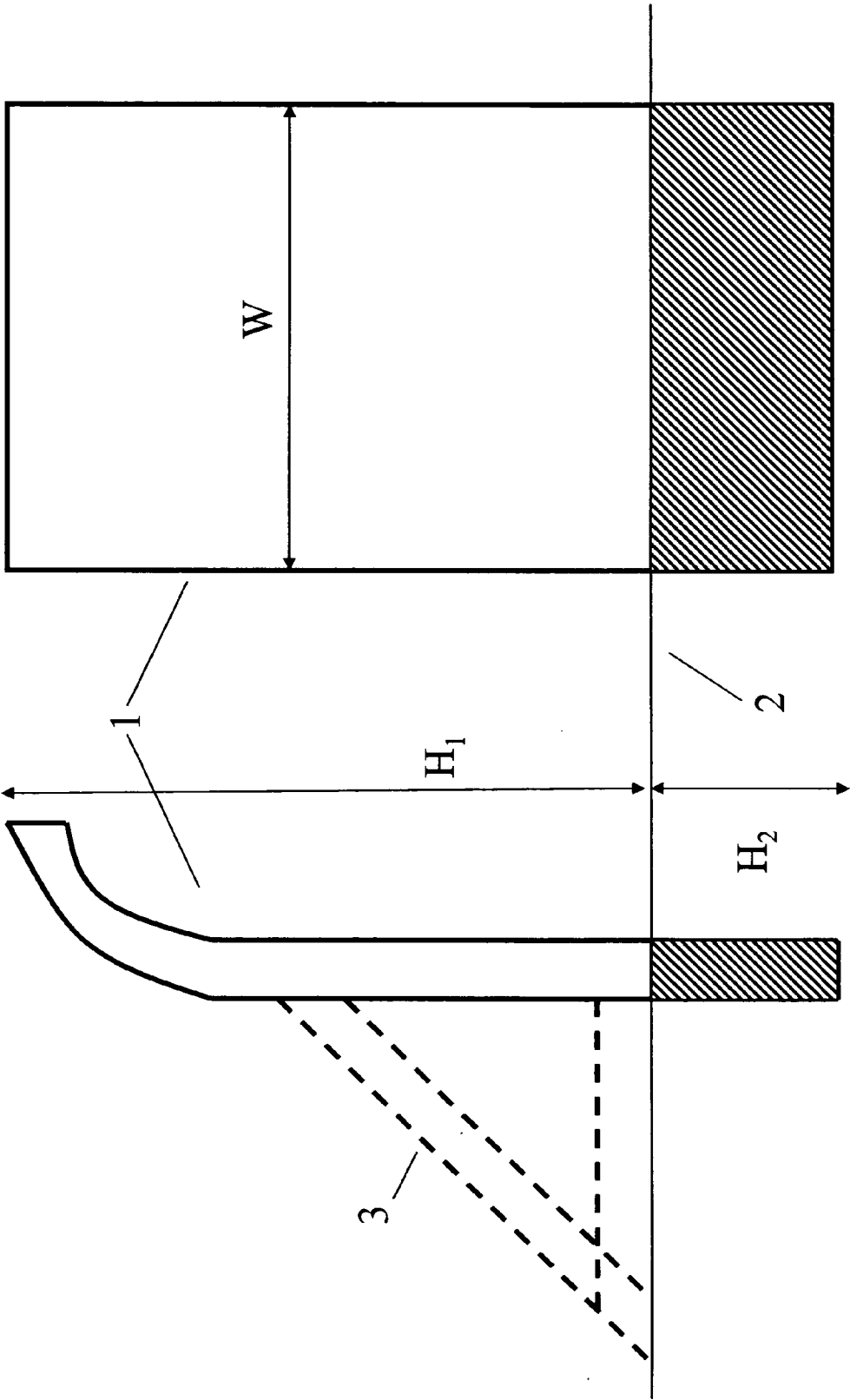

Fig. 1

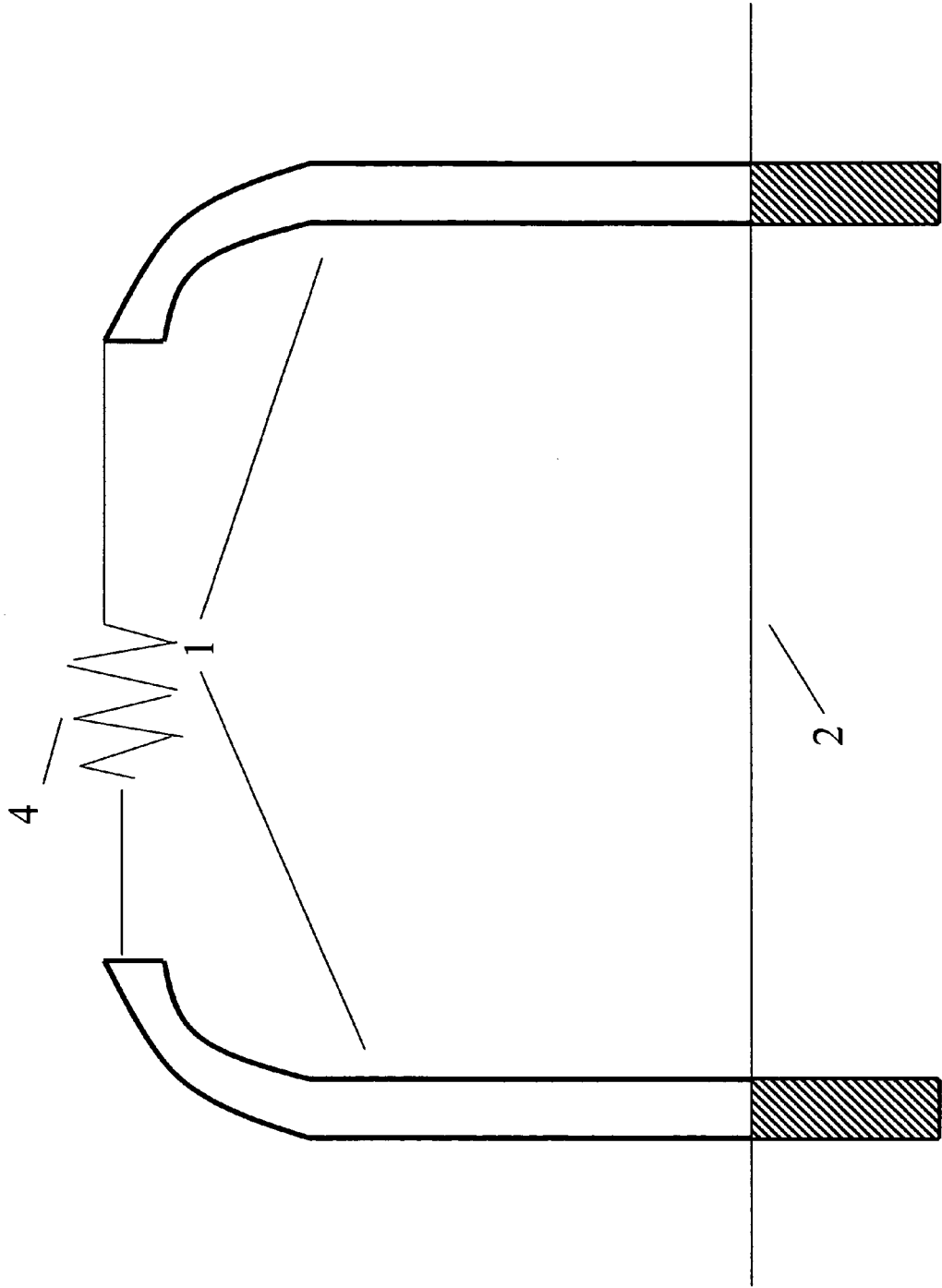

Fig. 2



Fig. 3e

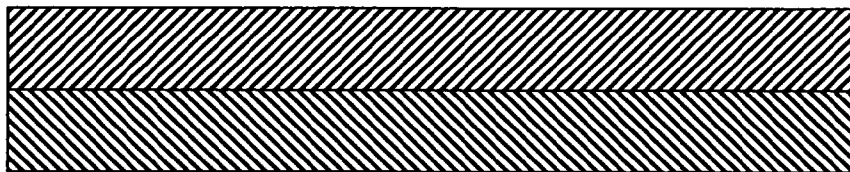

Fig. 3d

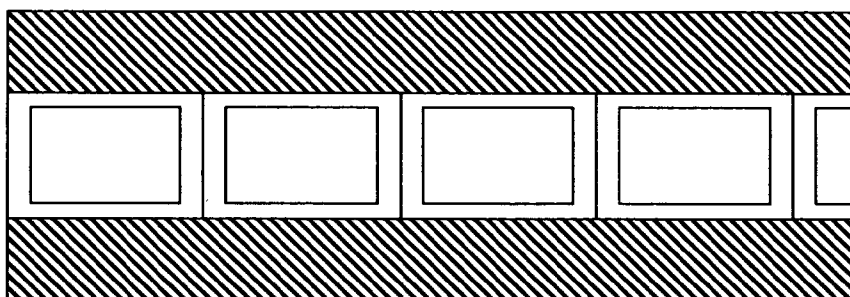

Fig. 3c

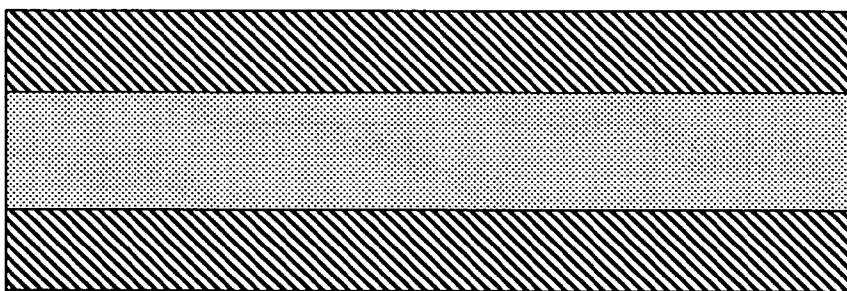

Fig. 3b

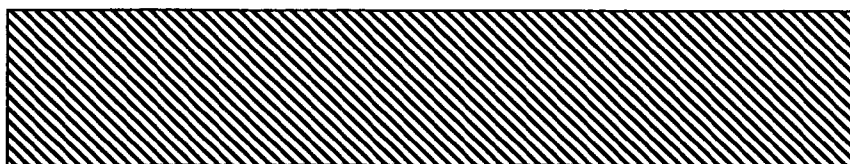

Fig. 3a

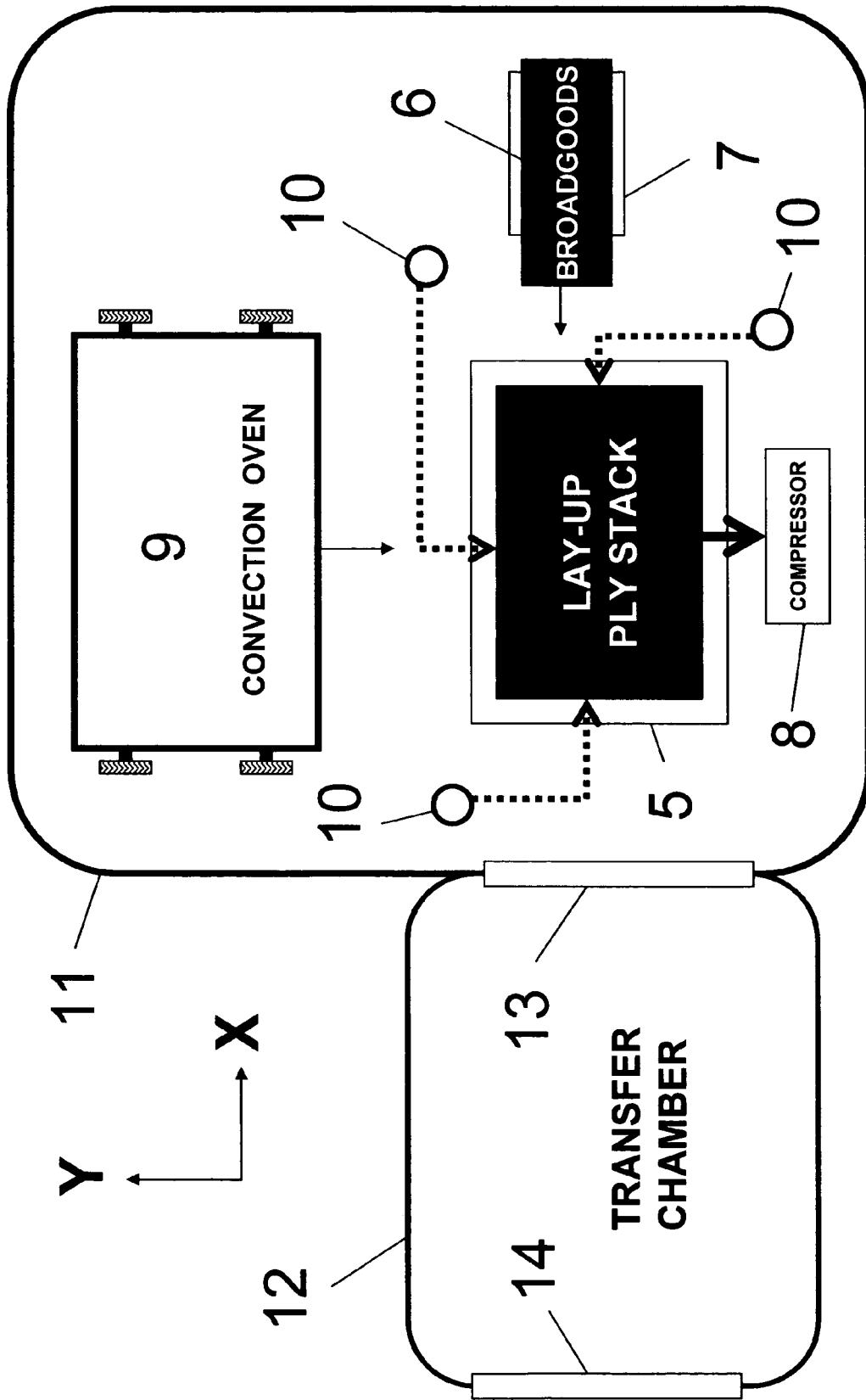

Fig. 4

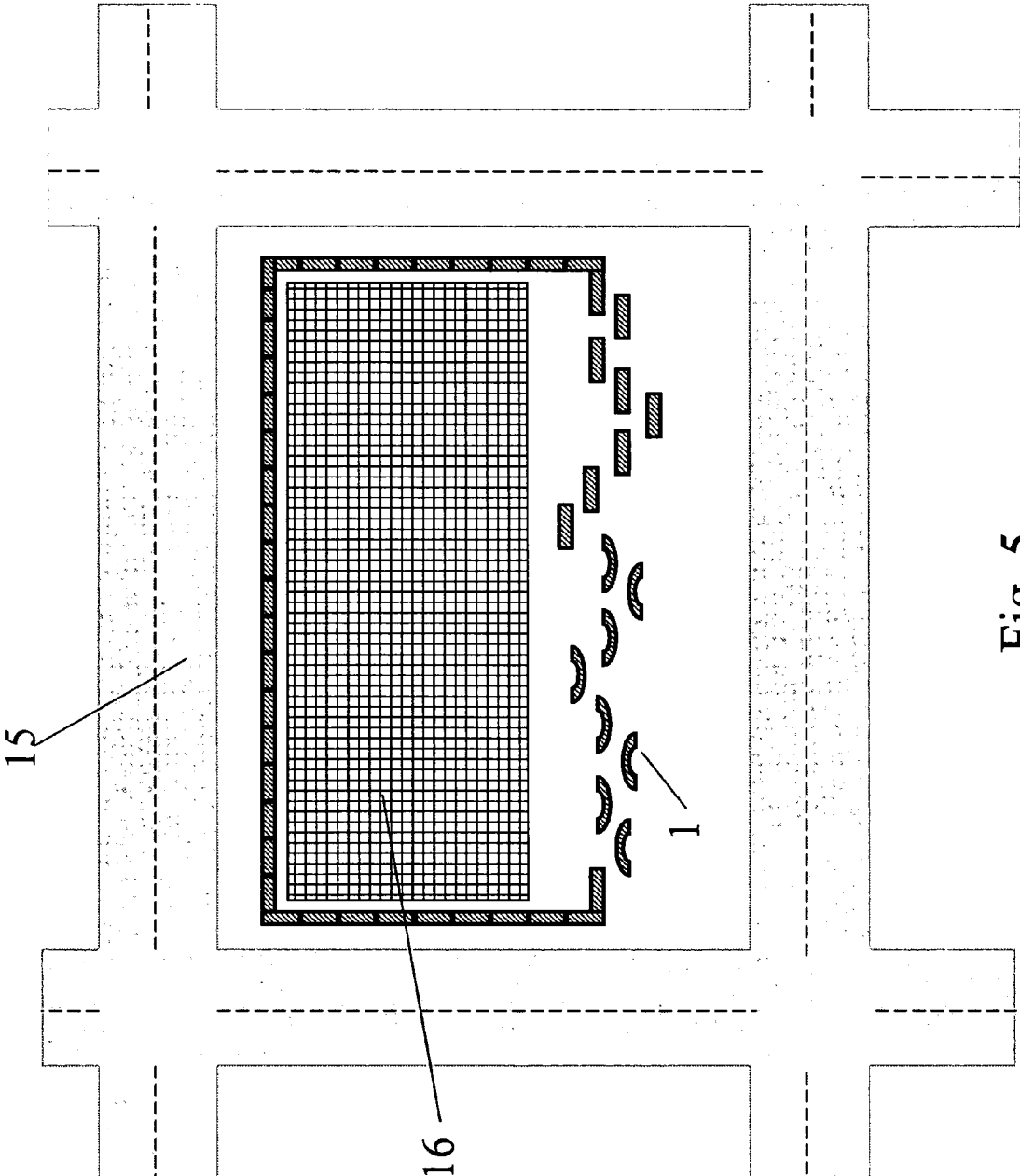

Fig. 5

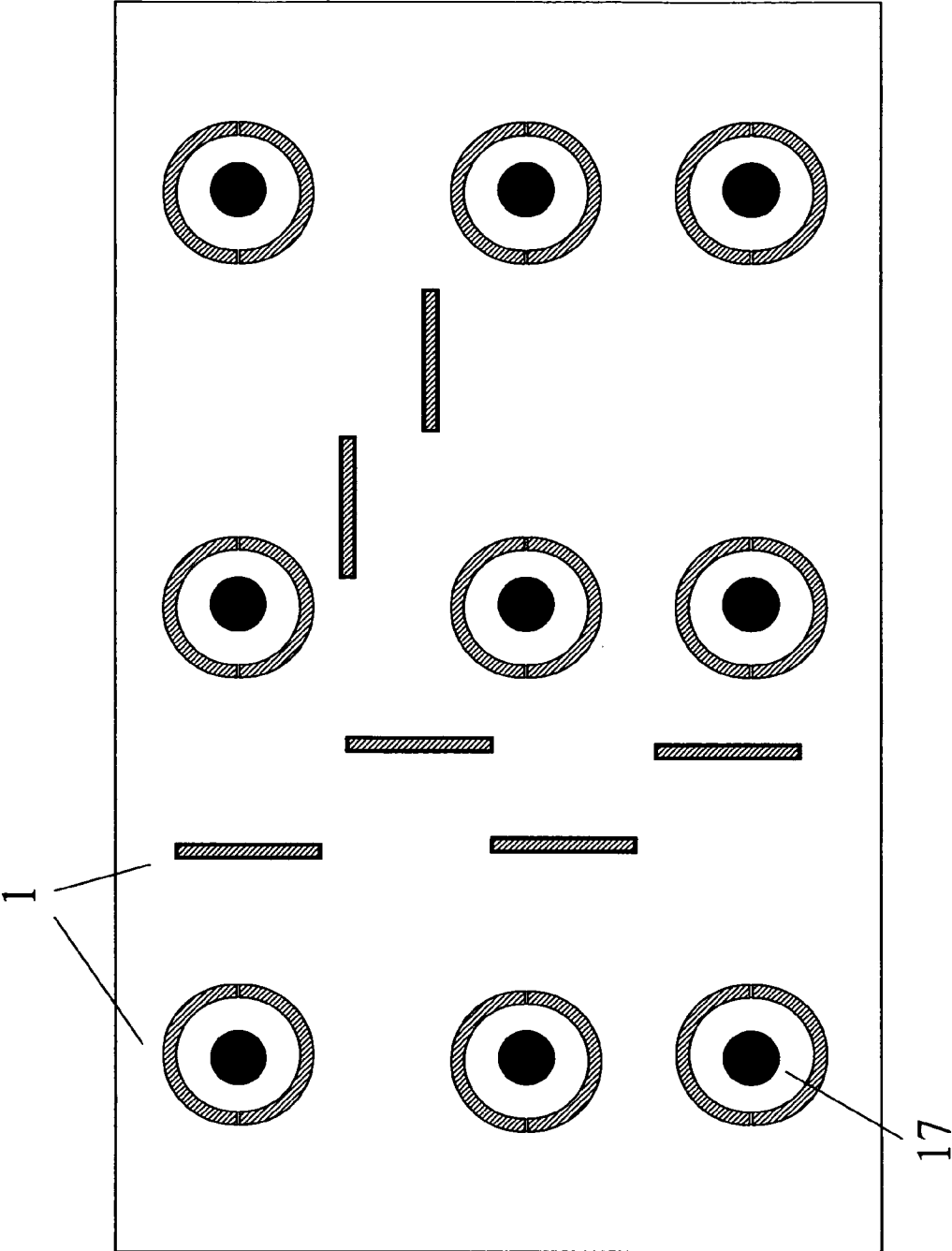

Fig. 6

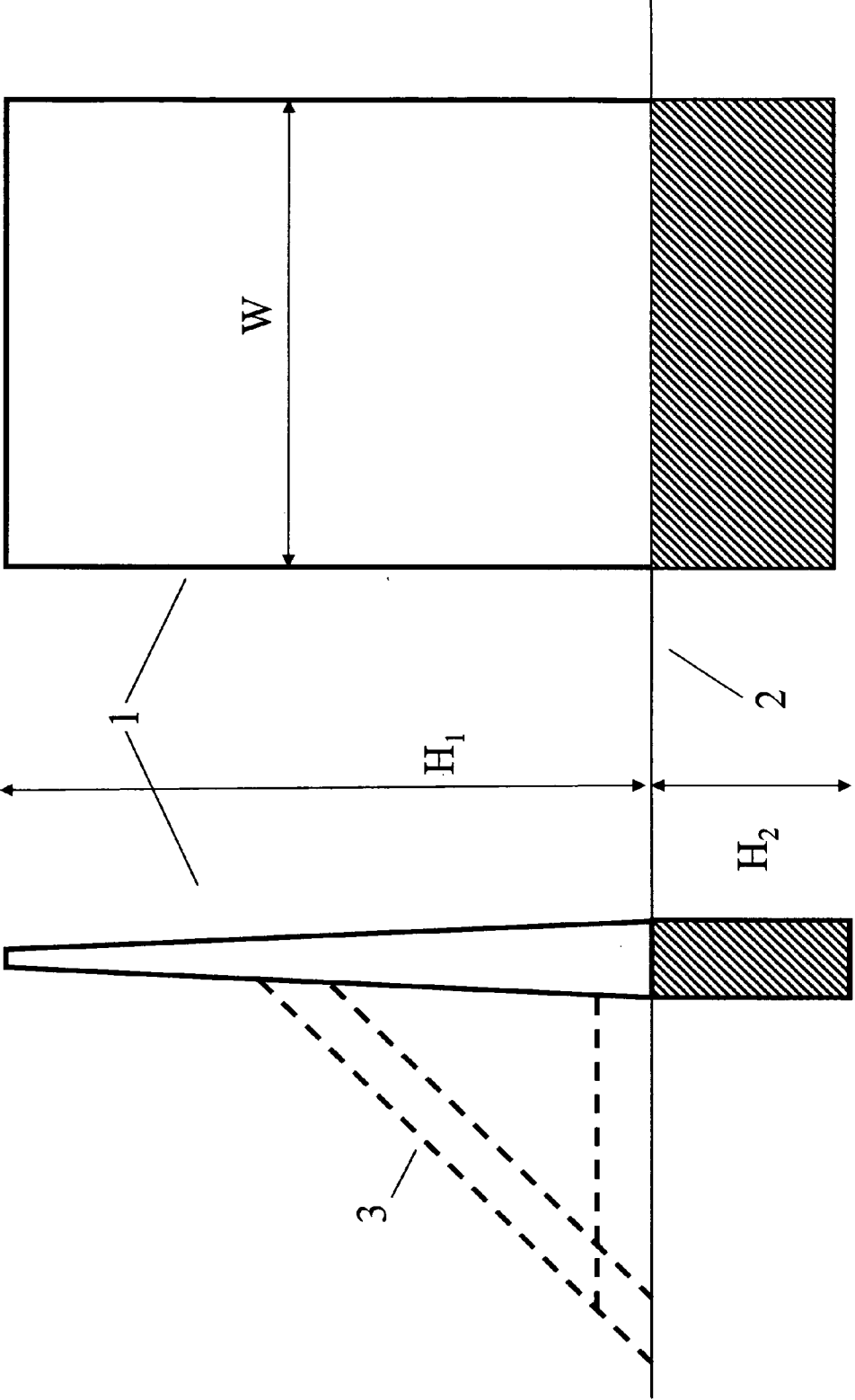

Fig. 7



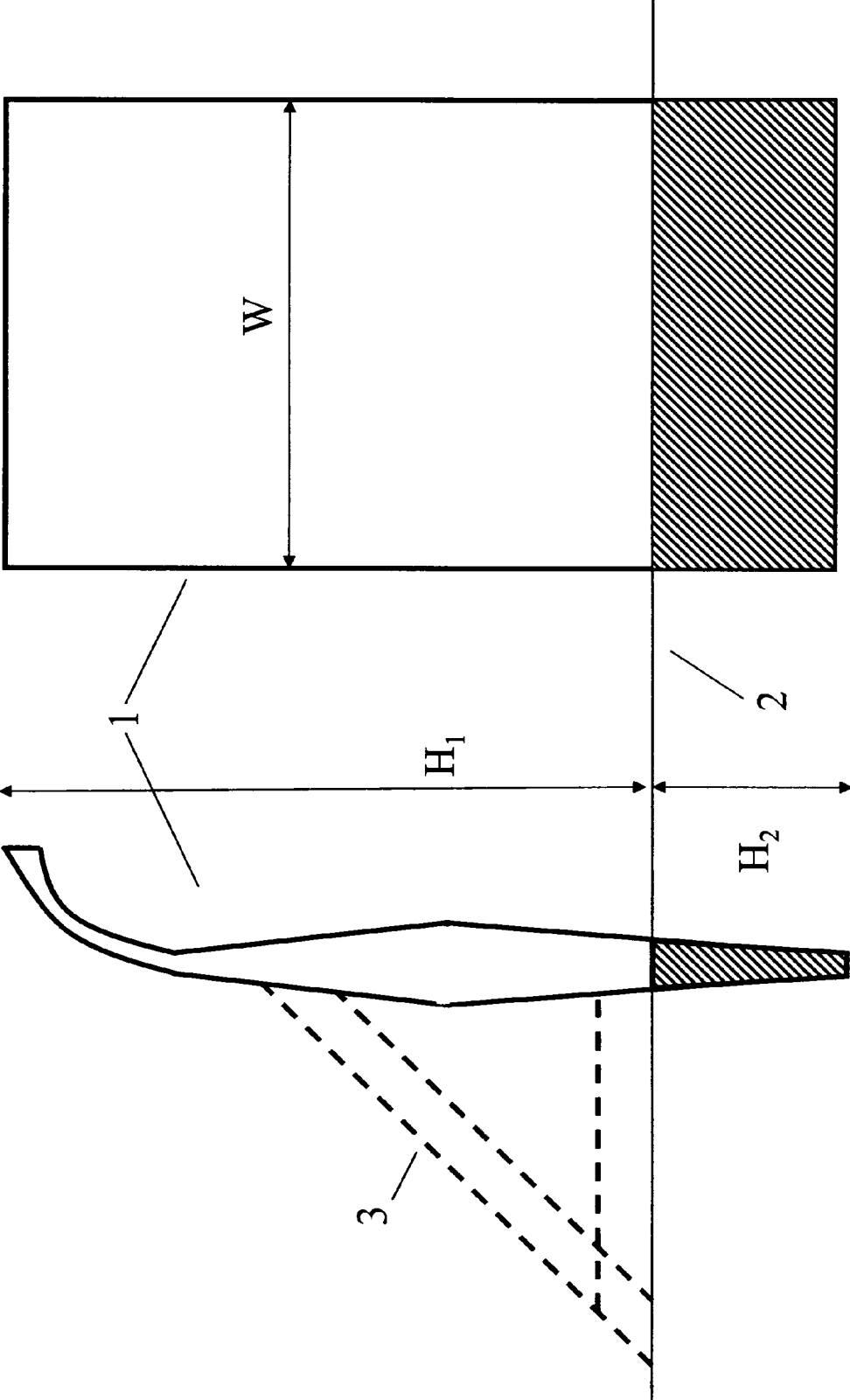

Fig. 8

**BLAST PROTECTION SYSTEM**

RELATED APPLICATIONS

[0001] This application is a continuation-in-part of U.S. application, Ser. No. 10/924,431, filed Aug. 23, 2004

FEDERALLY SPONSORED RESEARCH

[0002] Not Applicable

SEQUENCE LISTING

[0003] Not Applicable

BACKGROUND OF THE INVENTION

[0004] The invention relates to protection of structures or other sites from blasts due to bombs or other explosive devices. The invention is particularly suitable for protecting buildings from car or truck bombs such as may be used in terrorist activities. The invention is equally applicable to any site requiring protection from ground level or low level explosive attack. In addition to blast protection, the invention is also applicable to protection from high velocity projectiles and debris associated with natural events such as hurricanes or tornadoes.

[0005] One common, worldwide method used by terrorist organizations is to use a bomb which is installed in a car, truck or other vehicle. The vehicle is driven adjacent to a target, and the bomb is then detonated in close proximity to the target. Examples of such attacks are the Oklahoma City federal building incident, the attack on the marine base in Beirut, multiple examples of IRA operations, and more recently a series of attacks on foreign interests in Saudi Arabia and the nightclub bombing in Bali. Clearly, vehicle bombing is employed for destructive ends by a wide variety of terrorist organizations all over the world.

[0006] However, existing means of blast protection are very difficult to use to protect most sites. Steel or concrete barriers must be extremely massive to be effective. For instance a concrete barrier adequate to protect against a 1500 lb truck bomb would have to be 7 feet thick or in the case of a solid steel wall, 14 inches thick. Clearly such barriers are not feasible to protect existing buildings in downtown city areas, where the streets may only be the width of a sidewalk from the building. Moreover extremely large barriers are very difficult and time consuming to fabricate and erect, making it impractical to provide blast protection from vehicle threats to existing buildings. Finally massive barriers are not aesthetic and architecturally harmonious with the vast majority of sites. Having to mar the appearance and functionality of sites to protect them from terrorism can be considered a victory for the terrorist in and of itself. Clearly, a more practical means of blast protection would be an important tool in the struggle against world-wide terrorism. The present invention provides a superior approach to site protection from blasts.

BRIEF SUMMARY OF THE INVENTION

[0007] The invention is a blast protection barrier, including an above and below ground portion constructed entirely or in part of a blast resistant composite, where the below ground portion anchors the barrier. The construction is

preferably a fiber reinforced polymer matrix composite laminate. The barrier may also include external bracing, either angular, linear or both.

[0008] In a preferred embodiment, the barrier consists of sectional elements, arranged to form a pattern. One version of the pattern is, at least in part, the sectional elements arranged to form a continuous wall. In another version, the pattern is, at least in part, the sectional elements arranged in two or more rows to form a corridor. The corridor may be braced with cross pieces, the cross pieces having some degree of spring behavior. The cross pieces and corridor sections may be used as supports for signs, signals and sensors. In another version, the pattern is, at least in part, the sectional elements arranged to form a labyrinth or maze.

[0009] In another embodiment, the sectional elements include a portion providing lateral deflection of the blast and an overhanging portion providing at least partial vertical deflection of the blast. The barrier may also embody an entirely vertical wall. The sections may be colored and/or shaped to provide aesthetic and architectural value. Sections with curved shapes, both vertical and/or horizontal curved shapes, are contemplated.

[0010] In one embodiment the barrier is a composite laminate made from several layers or plies which make up the entire barrier thickness. The layers may be oriented at different angles with respect to one another. Each layer may utilize different fiber architectures, including but not limited to woven fabric, unidirectional tape, stitched reinforcement, or knitted reinforcement.

[0011] In a further embodiment, the barrier is a sandwich construction, of which at least one layer is the composite and at least one layer is a core material. The core materials in the sandwich may include but not be limited to, opened or closed cell foam, a honeycomb material, nomex, embedded I-beams of varying materials, or embedded composite pultrusions of constant cross-section along the length of the pultrusion.

[0012] In a further embodiment, the barrier is a hybrid laminate where part of the laminate total thickness uses one type of composite laminate and the other part of the thickness uses a different type of composite laminate.

[0013] In a further embodiment, the barrier is a hybrid laminate utilizing different composite material plies or layers from one layer to the next in an inter-leaved fashion.

[0014] In a preferred embodiment, the cross section of the above ground portion varies as a function of height above ground level, and the function is determined by the requirement to provide adequate thickness in the region of expected higher blast loading for the intended application, and also provide less thickness in regions of lower blast loading in order to lower the overall weight of the barrier, compared to a barrier of constant cross section.

[0015] In a version of the preferred embodiment, the cross section of the below ground portion varies as a function of depth below ground level, and the function is determined by the requirement to provide adequate thickness in the region of expected higher blast loading for the intended application, and also provide less thickness in regions of lower blast loading in order to lower the overall weight of the barrier compared to a barrier of constant cross section.

[0016] In another embodiment the barrier may have a cross-sectional shape that is determined by other requirements beyond blast loading. For instance, the barrier may be thickest in an area that is potentially more exposed to kinetic or ballistic threats.

[0017] In one specific embodiment, the function that determines the cross-section may be a taper, where the barrier is thickest at ground level and tapers toward the top, and, may taper below ground toward the bottom.

#### BRIEF DESCRIPTION OF THE DRAWINGS

[0018] The detailed description of how to make and use the invention will be facilitated by referring to the accompanying drawings.

[0019] FIG. 1 shows a blast barrier according to the invention

[0020] FIG. 2 shows one possible implementation of the invention.

[0021] FIG. 3 shows several examples of barrier construction according to the invention.

[0022] FIG. 4 illustrates a method for on-site construction of the novel barriers

[0023] FIG. 5 illustrates how the invention may be used to practically protect existing sites in crowded city environments.

[0024] FIG. 6 shows how the invention may be used to protect against an explosive blast detonation inside a structure.

[0025] FIG. 7 shows a preferred embodiment of the invention

[0026] FIG. 9 shows a version of the preferred embodiment

#### DETAILED DESCRIPTION OF THE INVENTION

[0027] The inventors have produced a completely new concept for blast protection, enabled in part by employing very different materials than currently used for this application. Current materials such as reinforced concrete or armor steel rely on traditional mechanisms to absorb blast energy. Conventional materials have compressive strength properties which are inadequately low to effectively resist blast overpressures, requiring a large amount of material to absorb a blast. Thus barriers made of these materials are massive, heavy and expensive. A new class of materials enables a different approach. Such materials are similar to fiberglass in that they utilize a reinforcing fiber architecture which is infused with a polymer resin matrix. The most effective version of composite construction utilizes materials which exhibit high compressive and tensile specific strengths and high compressive and tensile specific moduli. Specific strength is defined as the ultimate compressive (or tensile) strength of the material divided by its density. Specific modulus is the elastic compression (or tensile) modulus of the material divided by its density. The polymer resin matrix is resistant to galvanic corrosion, solvents and chemical agents. The inventors have developed a particularly suitable version of the material, described in a co-pending application. In this version, the fiber reinforcement

is treated with a special resin compatible sizing which develops a high specific laminate strength, high specific laminate modulus, high laminate strain to failure and high laminate fracture toughness. These materials exhibit much higher resistance to blast per unit volume than concrete or steel.

[0028] Such materials offer a very different type of blast protection system. For instance, the inventors' novel version of such a composite provides blast protection equal to more than 7 feet (2.13 m) of reinforced concrete with a thickness of 7.5" (19.5 cm.). A 10' by 10' by 7.5" (3.05 m by 3.05 m by 19.05 cm) section of the composite blast protection material will weigh approximately 7860 lbs (3573 kg). A 10' by 10' by 7' (3.05 m by 3.05 m by 2.13 m) section of reinforced concrete requires more than 11.5 times as much space and weighs 51.9 tons (47,182 kg). Obviously such a thickness of reinforced concrete is not a practical solution to protect a building in close proximity to streets and sidewalks. Moreover the size and weight of existing barriers makes for extremely difficult and time consuming installation. Clearly barriers of the composite type enable a much wider range of options to protect a site against a bomb blast.

[0029] Referring to FIG. 1, a preferred implementation of the invention is shown. A section of a blast barrier 1 consists of a portion  $H_1$  above the ground 2 and a portion  $H_2$  below ground. The composite barriers may be constructed and assembled as a continuous wall or as staggered discontinuous segments allowing walk through spaces for pedestrian traffic. The above ground portion is at least partially constructed of a composite of the type described above. The below ground portion, which anchors the section against the blast overpressure, does not have to be of composite construction. It may be preferable to use a heavier material for the anchor, and such an approach is contemplated by the invention. The above ground portion may be a variety of shapes. One particularly useful shape, as shown in FIG. 1 is to have the upper portion curve near the top to create an overhang. The overhang provides improved containment of the blast overpressure. Although the invention is not constrained by the actual dimensions, the inventors have found that a useful size for handling the 7.5" thick sections is a height,  $H_1$ , of 10' (3.05 m) or higher, a height,  $H_2$ , of 5' (1.52 m) and a width,  $W$ , of 10' (3.05 m). Such dimensions allow for a manageable number of sections to surround a building, enough height to protect against truck bombs, and a weight of under 6 tons (5359 kg) which is easily handled by small scale construction equipment and small work crews. The composite material has a large resistance to blast energy. Typically the limit to how big a blast can be withstood will be the ability of the anchoring to keep the barrier from rotating out of the ground. For larger threat scenarios, it may be advantageous to increase the barrier's ability to withstand blasts by increasing  $H_2$  or by adding additional bracing 3 (either cross or horizontal or both) as shown in FIG. 1.

[0030] Alternatively, as shown in FIG. 2, the sections may be arranged to form a corridor with walls on both sides of the roadway. Additional protection may be added with cross bracing as shown in FIG. 1, or by means of ties across the barriers, shown at 4. These ties must have some stiffness indicated by the spring at 4. When a bomb is detonated in the corridor between two barriers, the outward blast pressure exerted on both barriers, develops tensile forces in the ties

at 4. One use that can be made of either the barriers or ties is that they can be used as supports for road signs, traffic signals or sensors.

[0031] Although the composite must be used to obtain the required amount of blast protection per thickness, it may be advantageous to have other materials in the section as well. Other materials may be useful to provide additional benefit beyond blast protection. Such benefits include acoustic control, outer appearance, or firm connection to a different anchoring material. Also some combinations of material provide increased blast resistance, with weight and thickness trade-offs. FIG. 3a shows the simplest case in which the barrier is a composite laminate where each ply is the same material. As shown in FIG. 3b, the barrier may be of sandwich construction, where at least one layer is the composite and at least one layer is a core material. The core material in the sandwich may include but not be limited to, opened or closed cell foam, aluminum honeycomb, nomex, embedded I-beams of varying materials, or as shown in 3c, embedded composite pultrusions of constant cross-section along the length of the pultrusion. FIG. 3d shows the barrier as a hybrid laminate, where a portion of the laminate total thickness uses one type of composite laminate and the other portion of the thickness uses a different type of composite laminate. In 3e the barrier is a hybrid laminate utilizing different composite material plies or layers from one layer to the next in an inter-leaved fashion.

[0032] A particularly useful aspect of the invention is lightweight nature of the material and the relative ease with which segments may be fabricated and handled, permitting on-site construction of barrier segments. If, for example, it is desirable to retrofit an installation in a remote location, such as a military base in the Middle East, it is much more convenient to ship barrels of resin and rolls of reinforcement than to ship hundreds of wide, 6 ton, prefabricated sections. As long as a semi-controlled environment can be created and a forming tool available, the blast protection sections may be easily fabricated and assembled on-site. An example of an on-site fabrication facility is shown in FIG. 4. The elements shown in FIG. 4 must be in a relatively clean, air conditioned, temperature and humidity controlled environment. The inventors contemplate housing the facility in an enclosure, such as an air filled, positive pressure, fabrication tent. The elements include 5, a stationary lay-up tool. Broadgoods 6 are unrolled from the payout drum 7 and deposited on the lay-up tool, 5. The payout drum moves back and forth in the y direction to deposit broadgoods along the entire length of the lay-up tool, 5. A Compressor 8 draws one Atmosphere of vacuum for ply stack debulking (i.e. consolidation of stacked plies). The Compressor is also used for Resin Infusion if the Tool is stacked with dry Broadgoods rather than prepreg. The Convection Oven 9 rolls in the Y direction and can be raised and lowered over and onto the stationary Tool for Laminate Curing when Prepreg Broadgoods are used. The Oven consists of five insulated walls and a heater with a recirculating forced air blower. Resin drums and infusion lines 10 facilitate the resin infusion of the dry stack of Broadgoods. The facility may be housed in an inflatable, positive pressure, air conditioned Tent 11 with temperature and humidity control. A Positive Pressure Transfer chamber 12 is used to prevent loss of positive pressure in the fabrication Tent when removing the cured part from the Tent. After the cured part is moved into the pressurized transfer chamber, the Passageway 13 is sealed to prevent

loss of pressure in the fabrication Tent. Only after sealing Passageway 13 is the Transfer Chamber Exit 14 allowed to be opened.

[0033] The facility may include a vacuum assisted resin infusion capability. The vacuum being drawn on the bag sucks air out of the bag while sucking resin into the bag and simultaneously serves to consolidate the layers of reinforcement. The resin contains a catalyst, which initiates the curing of the consolidated stack of plies at ambient temperature. Alternatively, the inventors believe a pre-impregnation technique is preferable. In a further embodiment of the method, the reinforcing fiber is pre-impregnated (commonly referred to as prepreg) with partially cured (i.e. B-staged) resin while still in broadgoods tape or woven fabric form. A release film is applied to the prepreg broadgoods which is peeled off prior to the stacking of prepreg layers onto the Tool or mold. The prepreg stack is intermittently consolidated (i.e. debulked) by vacuum bagging until the required number of plies are deposited onto the Tool. The ply stack is vacuum bagged and oven cured to net thickness. This approach eliminates the need for using wet resin during the fabrication of barrier segments. The sections may be produced and cured in the on-site fabrication tent and moved and installed easily by a small work crew.

[0034] Referring to FIG. 5 the advantages conferred by the invention to practical site protection are shown. Many professed terrorist targets are existing financial and government facilities in cities. Such facilities are almost impossible to protect from street level threats with existing methods. Moreover, where protection is possible the massive and unattractive current blast barriers are a constant reminder that terrorism has in fact negatively impacted every day life. FIG. 5 shows an exemplary city block street grid 15 surrounding a potential target building 16. Most of the building will typically be adjacent to the streets. As shown by example in FIG. 5, three sides are separated from the streets by a sidewalk. Often, important buildings have a front facade that may be set back from the streets. Often the front includes some open space, and possibly several floors of open volume with glass fronts. Due to the facade and entry way, the building front is usually the most vulnerable part of the building and thus becomes the preferred location of terrorist attack using street level explosives. The open space in front may allow for some stand-off, such as commonly employed vehicle drive obstruction posts, which provide no blast protection. Using current techniques however, the perimeter of the building adjacent to the street cannot be protected at all. Thus, even though the sides of an unprotected building are typically stronger than the front, the sides present an unprotected target for attack by simply using a bigger bomb than required for the front. Insufficient space is available to install conventional type blast barriers on most parts of a city building. However, the current invention easily permits the installation of a blast barrier wall, using 7.5 inch (19.05 cm) thick sections 1, around the building without significantly impeding normal street and sidewalk usage.

[0035] The building front, with an open space and glass wall, may possibly have room for massive barriers. However, the implementation of such barriers is difficult from a construction standpoint and extremely unattractive. The novel barrier sections 1 arranged in a maze or labyrinth can be designed to allow free flow of pedestrian traffic through

the offset sections, and still provide effective blast protection. The sections **1** may be designed in shapes and colors that enhance the architecture and surroundings. FIG. **5** shows both straight and curved barrier segments, however, many shapes are possible and within the scope of the invention. The inventors believe that 360 degree all around protection could be installed with little impact on normal building operation or the surrounding environment. Although the city scenario is possibly the most advantageous implementation of the invention, rapid on-site fabrication and deployment ease applies even to sites that may have room for massive barriers.

[0036] As described above, minimizing the weight of the barrier sections while maintaining an adequate measure of protection is an important consideration in the use of blast barriers. Although the materials proposed herein for the novel barriers allow for much lighter barrier sections than conventional materials, depending on the nature of the anticipated threat to a particular installation, it is possible to further reduce the weight of the barriers. For many scenarios, the loading on the barriers due to anticipated blast threats will not be constant along the height of the barrier above ground. This situation allows for flexibility in setting the thickness of the barrier as a function of height.

[0037] FIG. **7** illustrates an example of a possible approach to minimizing weight of a barrier. Above ground portion **1** is shown as tapering from ground level from a thickest point to a thinnest point near the top. If the blast is expected to occur at a low height, such an approach provides highest loading resistance where the expected intensity is highest. Such a barrier would be much lighter than a barrier whose thickness was constant along the height with the thickness set by the highest loading intensity.

[0038] As shown in FIG. **8**, similar logic may be applied to the below ground portion **2**, which again may be configured to be thickest in the area of highest loading, and thinner elsewhere. Moreover, either portion **1** or **2** need not be shaped as a simple taper, but may assume other cross-sectional shapes, determined by a function whose purpose is to provide adequate resistance in regions of anticipated higher loading and thinner cross section in areas of lower anticipated loading, such that the result is adequate loading resistance along with lower weight. Also shown in FIG. **8**, the above ground portion may also have an overhang in the variable cross section implementation as well as in a constant cross-sectional implementation. The barrier may also vary in cross-section due to concerns other than blast loading. For instance the part of the barrier most likely to experience kinetic or ballistic threats, such as being rammed by a vehicle, may be above ground. The above-ground shape in FIG. **8** is a possible approach to a kinetic threat, whereby the thickness is adequate for a blast threat overall, but has a thicker section at a height deemed to be exposed to a kinetic threat. Other shapes, such as curved, or logarithmic, are also possible and are within the scope of the invention.

We claim:

**1.** a blast protection barrier, comprising: an above ground portion constructed entirely or in part of a blast resistant composite material wherein the cross section of the above ground portion varies as a function of height above ground level, and the function is determined by the requirement to;

provide adequate thickness in the region of expected higher blast loading for the intended application, and

provide less thickness in regions of lower blast loading in order to lower the overall weight of the barrier compared to a barrier of constant cross section.

**2.** The blast barrier of claim 1 further comprising external bracing, including angular bracing, linear bracing or both.

**3.** The blast barrier of claim 1 further comprising a below ground portion which anchors the barrier wherein the cross section of the below ground portion varies as a function of depth below ground level, and the function is determined by the requirement to;

provide adequate thickness in the region of expected higher blast loading for the intended application, and

provide less thickness in regions of lower blast loading in order to lower the overall weight of the barrier compared to a barrier of constant cross section.

**4.** The blast barrier of claim 1 wherein the composite material is a fiber reinforcement in a polymer resin matrix.

**5.** The polymer resin matrix of claim 4 wherein the polymer resin matrix is resistant to galvanic corrosion, solvents and chemical agents and exhibits a high specific strength, high specific modulus, high strain to failure, high fracture toughness and is not hygroscopic.

**6.** The fiber reinforcement of claim 4 where the fiber reinforcement is treated with a special resin compatible sizing which develops a high specific laminate strength, high specific Laminate modulus, high laminate strain to failure and a high laminate fracture toughness.

**7.** The blast barrier of claim 1 wherein the barrier consists of sectional elements, arranged to form a pattern.

**8.** The blast barrier of claim 7 wherein the pattern is, at least in part, the sectional elements arranged to form a continuous wall.

**9.** The blast barrier of claim 7 wherein the pattern is, at least in part, the sectional elements arranged in at least two rows to form a corridor.

**10.** The blast barrier of claim 9 further comprising cross pieces used as bracing, the crosspieces acting as springs.

**11.** The blast barrier of claim 10, wherein the barrier pieces and crosspieces may be used as support for signs, signals and sensors.

**12.** The blast barrier of claim 7 wherein the pattern is, at least in part, the sectional elements arranged to form a labyrinth or maze such that passage through the pattern is possible through offset sectional elements, but overlapping sectional elements provide blast protection.

**13.** The blast barrier of claim 7 wherein the sectional elements include a portion providing lateral deflection of the blast and a overhanging portion providing at least partial vertical deflection of the blast.

**14.** The blast barrier of claim 7 wherein the sectional elements may be colored and/or shaped to provide aesthetic and architectural value.

**15.** The blast barrier of claim 1 wherein the barrier is a sandwich construction, of which at least one layer is the composite laminate and at least one layer is a core material.

**16.** The blast barrier of claim 15 wherein the core material is an opened cell foam, a closed cell foam, a honeycomb material, nomex, embedded I-beams, embedded composite pultrusions or metal extrusions.

17. The blast barrier of claim 1 wherein the barrier is a composite laminate made from several layers or plies which make up the entire barrier thickness.

18. The blast barrier of claim 17 wherein the layers are oriented at different angles with respect to one another.

19. The barrier of claim 18, wherein each layer may utilize different fiber architectures, including woven fabric, unidirectional tape, stitched reinforcement, or knitted reinforcement.

20. The blast barrier of claim 1 wherein the barrier is a hybrid laminate where part of the laminate total thickness uses one type of composite laminate and the other part of the thickness uses a different type of composite laminate.

21. The blast barrier of claim 1 wherein the barrier is a hybrid laminate utilizing different composite material plies or layers from one layer to the next in an inter-leaved fashion.

22. The barrier of claim 1 wherein the cross-section is additionally determined by other parameters such as kinetic or ballistic threats.

23. The barrier of claim 1 where the function is a taper from a thickest point at ground level.

24. The barrier of claim 3 where the function is a taper from a thickest point at ground level.

\* \* \* \* \*